

Методика. Теоретическе исследование процессов разупрочнения горной породы при нестационарном термическом воздействии на основе теории термоупругости. Выполнен сравнительный анализ термонапряженного состояния породы при бурении с импульсным и постоянным режимами промывки.

Результаты. Определены условия перехода трещин в подвижное состояние и снижение прочности породы. Получены расчетные соотношения для скорости развития трещин и времени задержки процесса разрушения. Показано, что при импульсном режиме подачи промывочной жидкости в горной породе создаются условия для термического разрушения. За счет более высокой, чем для режима с постоянной промывкой, амплитуды температуры на забое скважины происходит разупрочнение поверхностного слоя горной породы. При бурении по граниту среднее снижение прочности составляет 12 %.

Научная новизна. Впервые выполнен анализ термонапряженного состояния породы и обоснова-

на возможность использования термоциклического эффекта для повышения эффективности процесса разрушения горной породы при бурении алмазными коронками. Впервые определены характеристики процесса термического разрушения породы: минимальные размеры трещин и минимальное время задержки начала разрушения, выполнена оценка снижения прочности породы для алмазного бурения. Показано, что технология импульсной подачи промывочной жидкости способствует снижению энергоемкости процесса разрушения породы.

Практическая значимость. Результаты работы могут быть использованы при разработке технологий импульсного бурения скважин, для определения энергоэффективных параметров процесса.

Ключевые слова: алмазное бурение, импульсная промывка, температурные напряжения

Рекомендовано до публікації докт. техн. наук О. М. Давиденком. Дата надходження рукопису 22.06.15.

Chen Zijian¹,
Yu Baohua¹,
Yuan Junliang²,
Zhang Yanan¹,
Deng Jingen¹

1 – State Key Laboratory of Petroleum Resource and Prospecting, China University of Petroleum, Beijing, China
2 – China National Offshore Oil Corporation Research Institute, Beijing, China

DETERMINATION OF FRACTURE TOUGHNESS OF ROCKS OF A SHALE GAS RESERVOIR USING STRAIGHT-NOTCHED BRAZILIAN DISC (SNBD) SPECIMEN AND WELL LOGS

Чень Цицзянь¹,
Юй Баухуа¹,
Юань Юньлян²,
Чжан Янань¹,
Ден Джингень¹

1 – Державна провідна лабораторія запасів нафти та розвідувальних робіт, Китайський Нафтовий Університет, м. Пекін, Китай
2 – Дослідний Інститут Китайської національної шельфової нафтової корпорації, м. Пекін, Китай

ВИЗНАЧЕННЯ МІЦНОСТІ НА РОЗРИВ ПОРІД РОДОВИЩА СЛАНЦЕВОГО ГАЗУ З ВИКОРИСТАННЯМ ЗРАЗКА ПРЯМОШОВНОГО БРАЗИЛЬСЬКОГО ДИСКА (SNBD) І КАРОТАЖУ

The straight-notched Brazilian disc (SNBD) specimen is used to test the mode-I and mode-II fracture toughness of a shale gas reservoir. The tests are conducted on 14 shale specimens which are taken from the shale gas reservoir in the southwest Chongqing, China. The technique of high-pressure water jet cutting is applied to process the pre-existing notch within specimens to avoid the influence of central hole on the notch to ensure the accuracy of the testing results. Based on the testing results, mode-I and mode-II fracture toughness prediction models of the shale gas reservoir are established. The predicted fracture toughness and testing results show good agreement. The results indicate that the mode-I and mode-II fracture toughness of the shale gas reservoir are in direct proportion to the rock density and interval transit time, and inversely proportional to the shale content. The prediction models can be used to establish continuous fracture toughness profiles of the shale gas reservoir and effectively guide the selection of optimal layer before hydraulic fracturing.

Key words: shale gas reservoir, straight-notched Brazilian disc, fracture toughness, well logging

Introduction. Shale gas is a kind of indispensable unconventional energy resource. The USA Energy Information Administration has predicted that the shale gas reserves all around the world may be up to $623 \cdot 10^{12} \text{ m}^3$, which means there is an abundant potential for shale gas development. Acting as the reservoir and the hydrocarbon generation layer simultaneously, the shale gas reservoir has characteristics of low porosity and low permeability, which would result in low production. Thus, the horizontal drilling and the stimulated reservoir volume by hydraulic fracturing are required to obtain high production output. In order to obtain high production output, the geological ‘sweet spot’ of perfect stimulated reservoir volume needs to be discovered. Therefore, the shale gas reservoir fracturing evaluation is of great importance, and the fracture toughness is a significant property to evaluate the fracturing effectiveness of the shale gas reservoir.

The fracture toughness indicates the material ability to prevent crack from unstable propagating. The higher the fracture toughness is, the more difficult the crack extends. According to the type of crack, fracture toughness can be divided into mode-I (opening mode crack), mode-II (sliding mode crack) and mode-III (tearing mode crack). All cracks can be formed by the superposition of these three basic types, and called composite crack or mixed crack. The general types of crack which come into being during the hydraulic fracturing of the shale gas reservoir are the opening mode crack (mode-I) and sliding mode crack (mode-II). The mixed cracks form in the formation where intense variation of in situ stress or lithology exists [1].

There have been various kinds of testing methods for determining mode-I fracture toughness. The International Society for Rock Mechanics (ISRM) recommended that Chevron notched three-point bend round bar (CB) specimen and chevron notched short rod (SR) specimen should be used to test the mode-I rock fracture toughness in 1988 and then proposed cracked chevron notched Brazilian disc (CCNBD) specimen in 1995. Compared to SR and CB, method using CCNBD specimen is of much higher failure loads, fewer restrictions on the testing apparatus, larger tolerance on the specimen machining error, simpler testing procedure and lower scatter of test results. However, the testing result of CCNBD specimen is slightly lower than the former two methods [2]. In addition, the notched thick-walled cylinder specimen was also used by Clifton R.J. et al. to determine mode-I fracture toughness. The studies of mode-II fracture toughness test are fewer than mode-I fracture toughness and the testing methods involve anti-symmetric four-point bending test, edge-cracked Arcan test, compact tension-shear test and short beam compression test.

Actually, there is another easier method to test mode-I and mode-II fracture toughness. Awaji H. et al. proposed that the mode-I and mode-II fracture toughness can be tested by SNBD specimen while Atkinson C. et al. analyzed the normalized stress intensity factors under a certain condition using SNBD specimen. However, the size standard of the SNBD

specimen is extreme and it is hard to meet. Generally, a small hole is drilled in the center of the disc and then the pre-existing notch is cut by metal wire or diamond saw [3–4]. The unavoidable central hole diameter of at least 3 mm and pre-existing notch width of at least 0.25 mm would lead to the produced crack that does not belong to the pure opening mode crack or sliding mode crack, and the specimen is easy to collapse, as shown in Fig. 1 and Fig. 2. Therefore, there are still some problems for SNBD specimen testing to solve in order to obtain expected testing results.

The relationships between the mode-I or mode-II fracture toughness and rock physical properties have been tested and discussed on sandstone, claystone, limestone, granite and marble [1, 3]. The results showed that the fracture toughness of these kinds of rock is directly proportional to the confining pressure, temperature, tensile strength, elastic modulus and compressive strength, but is inversely proportional to the shale content. Furthermore, Al-Shayea N.A. and Jin Yan respectively proposed the fracture toughness calculation formula for limestone and sandstone [1, 3]. Zhao Fei used the SNBD specimen to test the fracture toughness of shale outcrop, but the results are not optimum because of the low-level processing technology and the relationship between the shale gas reservoir and logging data cannot be obtained [4]. The cost of drilling coring is very high and the evaluation of fracture toughness by laboratory testing cannot help to obtain a continuous fracture toughness profile, so the relationship between the fracture toughness of the shale gas reservoir and the logging data is very valuable.

To sum up, there are still some research deficiencies regarding the fracture toughness of the shale gas reservoir: 1) in the process of using the SNBD specimen for the measurement of fracture toughness, the diameter

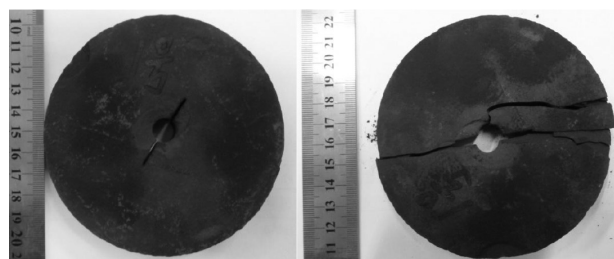

Fig. 1. The mode-I fracture toughness testing result obtained by Zhao Fei et al. in 2013



Fig. 2. The mode-II fracture toughness testing result obtained by Zhao Fei et al. in 2013

of men-made central hole was so large that occupied the pre-existing notch. As a result, the produced crack was no longer pure opening mode crack or sliding mode crack, and the arch bridge type of collapse occurred; 2) there are some experimental studies for the fracture toughness of the shale outcrop but not the shale gas reservoir, and the results are not optimum.

In order to obtain the prediction model of fracture toughness of the shale gas reservoir, the specimens in this paper are taken from the shale gas reservoir in the southwest Chongqing, China. In addition, the high-pressure water jet method is applied to make the notch in order to guarantee the accurate testing result. Furthermore, a direct relationship between the fracture toughness of the shale gas reservoir and the logging data is established. The prediction model is used to establish continuous fracture toughness profiles of the shale gas reservoir and guide the selection of optimal layer before hydraulic fracturing.

Fracture toughness test. Specimen preparation. The shale specimens are taken from the well-X in the southwest Chongqing, China. The depth is 1206–1223 m, belonging to Longmaxi group of Silurian System. The diameter of the original core column is about 5 cm. With a professional cutting machine applied perpendicular to the original core column, the original core column is cut into several core plates of about 2.5 cm thick. In order to ensure that the tests have required discrete degree, the interval between each specimen is about 5 cm. Then the grinder machine is used to smooth two sides of the core plate to make sure that both sides are smooth, parallel (the parallelism is less than 0.5 mm) and perpendicular to the central axis.

Then, the notch is made by the means of a high-pressure water jet method. A hole is drilled in the middle of the specimen by the water jet which contains sharp abrasive. The nozzle diameter is adjusted to make the diameter of the hole smaller than 1 mm. After the specimen is penetrated and the hole is drilled, the nozzle is moved up to 0.7 cm in the radial direction. When the half of the notch is finished, the other half of the notch is made in a similar way. The whole notch is about 1.4 cm long. Compared to the specimen made by Al-Shayea N.A. and Zhao Fei, the central hole of the specimen in this paper is too small to affect the testing result, as illustrated in Fig. 3.

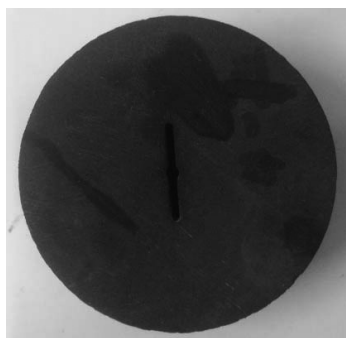

Fig. 3. SNBD Specimen made by high-pressure water jet method

Test process. The SNBD specimen tests are carried on the Fracture Toughness Test Machine owned by the Rock Mechanics Laboratory of China University of Petroleum (Beijing). The specimens are divided into two groups to respectively test mode-I fracture toughness K_I and mode-II fracture toughness K_{II} . As shown in Fig. 4, the angle between the notch and the loading direction is respectively 0° and 30° (actually it is about 27.5°), which indicates that the tested fracture toughness is respectively mode-I fracture toughness and mode-II fracture toughness. In the beginning of the test, a small vertical load is exerted by the hydraulic pressure head. It is to guarantee the stability of the specimen, and then different angles are set. Next, the vertical load is applied on the specimen using electro-hydraulic servo pressure system. The loading process is in displacement loading pattern and the loading rate is 0.1 mm/min. The initiation and extension process of the micro crack within the specimen is recorded with the acoustic emission instrument and the load is collected by the computer until the specimen fractures completely.

Test results analysis. Atkinson C. has deduced the formulas of mode-I fracture toughness and mode-II fracture toughness which are tested by disc-shaped specimen, as follows

$$K_I = \frac{P\sqrt{a}}{RB\sqrt{\pi}} N_I;$$

$$K_{II} = \frac{P\sqrt{a}}{RB\sqrt{\pi}} N_{II}.$$

Where P is the applied radial load, kN; a is the semi-length of notch, cm; R is the radius of disc, cm; B is the thickness of disc, cm; N_I and N_{II} are respectively mode-I and mode-II dimensionless stress intensity factors; K_I and K_{II} are respectively mode-I and mode-II fracture toughness, $\text{MPa} \cdot \text{m}^{0.5}$.

When $a/R \leq 0.3$,

$$N_I = 1 - 4\sin^2 \theta + 4\sin^2 \theta (1 - 4\cos^2 \theta) \left(\frac{a}{R}\right)^2;$$

$$N_{II} = \left[2 + (8\cos^2 \theta - 5) \left(\frac{a}{R}\right)^2 \right] \sin 2\theta.$$

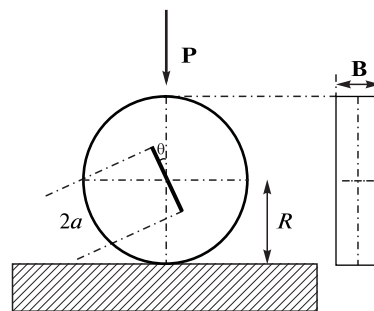

Fig. 4. Size of fracture toughness test specimen by SNBD

Where θ is the angle between the notch and the loading direction. The specimen in this paper meets the condition of $a/R \approx 0.28 \leq 0.3$.

Table 1 and Table 2 display the fracture toughness testing results. The discrete degree of the mode-I fracture toughness is small, which indicates that the difficulty of the generation of tensile fracture in the shale gas reservoir is almost the same. However, the mode-II fracture toughness results are relatively dispersed, meaning that the difficulty of the generation of shear fracture varies considerably. The mode-I fracture toughness is about $0.766 \text{ MPa} \cdot \sqrt{m}$ and the mode-II fracture toughness is about $0.984 \text{ MPa} \cdot \sqrt{m}$ when the abnormal value of 0.346 is removed.

Fig. 5 illustrates the comparison of the specimen before and after the test of mode-I fracture toughness. The macroscopic crack caused by the fracture spreads along the notch direction and penetrates the entire specimen. The specimen breaks apart into relatively simple forms producing few blocks. This kind of failure is in accordance with pure opening mode crack.

Fig. 6 illustrates the comparison of the specimen before and after the test of mode-II fracture toughness. There is an angle between the macroscopic crack caused by the fracture and the notch direction, and the crack also penetrates the entire specimen. The form of the broken specimen is considerably complicated and

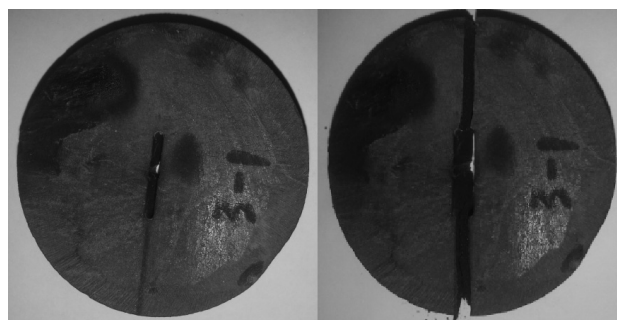

Fig. 5. Comparison of the specimen 3-1 before and after the test of mode-I fracture toughness

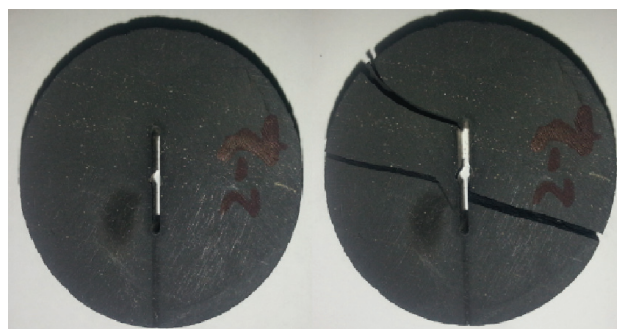

Fig. 6. Comparison of the specimen 2-2 before and after the test of mode-II fracture toughness

Table 1

Testing results of mode-I fracture toughness of the shale gas reservoir

NO.	a (cm)	R (cm)	B (cm)	θ (°)	P (kN)	K ($\text{MPa} \cdot \text{m}^{0.5}$)
1-1	0.7	2.78	2.09	0	9.492	0.771
2-1	0.7	2.43	2.48	0	10.275	0.805
2-3	0.7	2.44	2.03	0	7.41	0.706
3-1	0.7	2.795	2.04	0	10.152	0.840
3-3	0.7	2.8	2.24	0	10.77	0.811
4-2	0.7	2.78	2.43	0	10.079	0.704
6-1	0.7	2.785	2.75	0	11.739	0.724

Table 2

Testing results of mode-II fracture toughness of the shale gas reservoir

NO.	a (cm)	R (cm)	B (cm)	θ (°)	P (kN)	K ($\text{MPa} \cdot \text{m}^{0.5}$)
1-2	0.7	2.785	2.13	30	2.432	0.346
2-2	0.7	2.435	2.05	30	6.111	1.042
3-2	0.7	2.795	1.78	30	8.451	1.432
4-1	0.7	2.79	2.64	30	5.266	0.603
5-1	0.7	2.815	2.67	30	8.502	0.953
5-2	0.7	2.83	2.25	30	7.76	1.027
6-2	0.7	2.79	1.99	30	5.586	0.848

some blocks are produced. The main kind of failure is pure sliding mode crack which indicates mode-II fracture toughness.

Fracture toughness prediction model. Prediction of fracture toughness by well logging data. In order to obtain continuous fracture toughness profiles, the direct relationships between the fracture toughness and the logging data are inverted and discussed. The measured fracture toughness is considered the objective function and the shale density, gamma, interval transit time are taken as the independent variables. The multiple regression method is applied and several types of prediction models are deduced. To improve the accuracy, the interval transit time is transformed into logarithm, and the gamma value is transformed into shale content. Thus, several possible mode-I and mode-II fracture toughness prediction models of the shale gas reservoir are obtained as follows

$$K_I = 0.4449\rho + 0.1272 \lg(DT) - 0.1474 \exp(Vcl) - 0.3068;$$

$$K_I = 0.3415\rho + 0.3917 \lg(DT) + \frac{0.0466}{Vcl} - 0.8907; \quad (1)$$

$$K_{II} = 1.9291\rho + 2.2424 \lg(DT) - 0.2832 \exp(Vcl) - 7.2516;$$

$$K_{II} = 1.8686\rho + 2.7782 \lg(DT) + \frac{0.1036}{Vcl} - 8.7927. \quad (2)$$

Where, K_I is the mode-I fracture toughness, $\text{MPa} \cdot \sqrt{m}$; K_{II} is the mode-II fracture toughness,

$\text{MPa} \cdot \sqrt{m}$; ρ is the shale density, g/cm^3 ; Vcl is the shale content; DT is the interval transit time, $\mu\text{s/ft}$.

Model prediction. The logging data of the depth where the specimens exist are described in Table 3 and Table 4. Equation (1, 2) with a relatively higher correlation coefficient are chosen to predict the mode-I and mode-II fracture toughness respectively. The comparisons of the measured and calculated mode-I and mode-II fracture toughness are also displayed in Table 3 and Table 4 respectively. The results indicate that Equation (1) has a really small relative error of no more than 6.68 %. Even though the relative error of Equation (2) varies considerably, the accuracy and relative correlation of Equation (2) are really high if the abnormal value is removed. Fig. 7 and Fig. 8 illustrate the comparison of the measured and calculated fracture toughness. Most of the points are close to the unit-slope straight line, meaning the inverted prediction model of mode-I and mode-II fracture toughness both have enough accuracy.

Table 3

Comparison of measured and calculated mode-I fracture toughness

NO.	ρ (g/cm^3)	DT ($\mu\text{s/ft}$)	Vcl	Measured K_{I1} ($\text{MPa} \cdot \text{m}^{0.5}$)	Calculated K_{I1} ($\text{MPa} \cdot \text{m}^{0.5}$)	Relative Error (%)
1-1	2.58	59.75	0.80	0.771	0.745	3.426564
2-1	2.52	67.15	0.57	0.805	0.767	4.682214
2-3	2.31	60.62	0.45	0.706	0.699	1.006202
3-1	2.38	58.93	0.23	0.840	0.817	2.778723
3-3	2.42	63.67	0.25	0.811	0.831	2.518289
4-2	2.48	60.27	0.48	0.704	0.751	6.685772
6-1	2.55	65.69	0.80	0.724	0.751	3.744578

Table 4

Comparison of measured and calculated mode-II fracture toughness

NO.	ρ (g/cm^3)	DT ($\mu\text{s/ft}$)	Vcl	Measured K_{II} ($\text{MPa} \cdot \text{m}^{0.5}$)	Calculated K_{II} ($\text{MPa} \cdot \text{m}^{0.5}$)	Relative Error (%)
1-2	2.23	59.65	0.80	0.346	0.437	26.52136
2-2	2.55	59.12	0.57	1.042	1.076	3.22473
3-2	2.6	58.89	0.23	1.432	1.431	0.070001
4-1	2.26	61.15	0.48	0.603	0.611	1.320505
5-1	2.47	67.66	0.63	0.953	1.073	12.51455
5-2	2.4	62.51	0.64	1.027	0.844	17.84145
6-2	2.35	65.55	0.76	0.848	0.781	7.978592

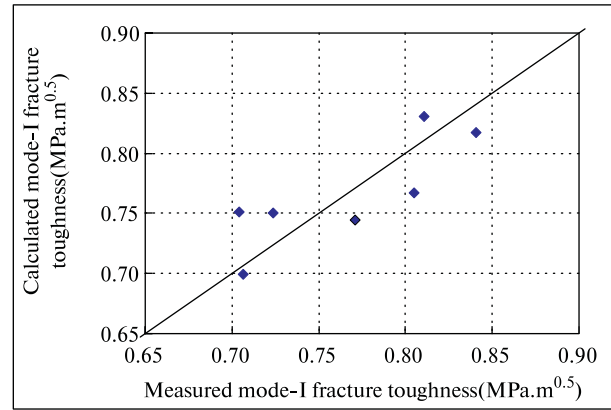

Fig. 7. Comparison of the measured and calculated mode-I fracture toughness

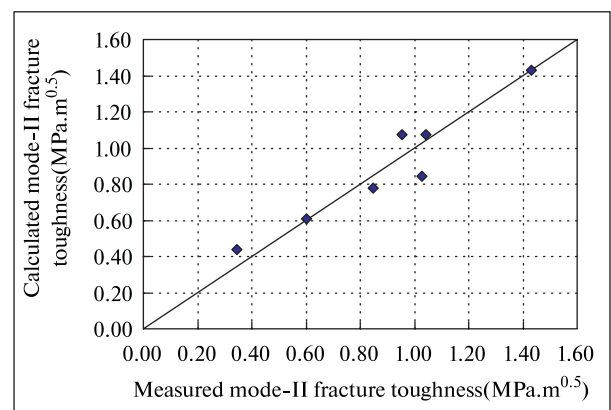

Fig. 8. Comparison of the measured and calculated mode-II fracture toughness

The prediction models indicate that mode-I and mode-II fracture toughness of the shale gas reservoir are both in direct proportion to the rock density and interval transit time, and inversely proportional to the shale content. The higher the shale content is, the smaller the fracture toughness is, and it is easier for the fracture to extend. The results could be used to effectively establish the fracture toughness profile of the shale gas reservoir and guide the selection of optimal layer before hydraulic fracturing.

Conclusions. The shale specimens from the shale gas reservoir in the southwest Chongqing are applied to test the mode-I and mode-II fracture toughness. The testing results indicate that the application of high-pressure water jet cutting technology effectively excludes the influence of the central hole on the pre-existing notch of SNBD specimen, and the pure opening mode crack and sliding mode crack are obtained.

The prediction models of the mode-I and mode-II fracture toughness of the shale gas reservoir based on logging data are established. The mode-I and mode-II fracture toughness of the shale gas reservoir are both in direct proportion to the rock density and interval transit time, and inversely proportional to the shale content. The higher the shale content is, the smaller the fracture toughness is. The calculated and measured

results are very close, indicating that the prediction models can guide selecting optimal layer before hydraulic fracturing.

Acknowledgments. This work is financially supported by Science Fund for Creative Research Groups of the National Natural Science Foundation of China (Grant No. 51221003) and National Natural Science Foundation Project of China (Grant No. 51134004).

References / Список літератури

1. Jin Yan, Chen Mian, Zhang Xudong, 2001. Determination of Fracture Toughness for Deep Well Rock with Geophysical Logging Data, Chinese Journal of Rock Mechanics and Engineering, 20(4), pp. 454–456.
2. Dwivedi, R.D., Soni, A.K., Goel, R.K., 2000. Fracture toughness of rocks under sub-zero temperature conditions, International Journal of Rock Mechanics and Mining Sciences, 8(37), pp. 1267–1275.
3. Al-Shayea, N.A., Khan, K., Abduljauwad, S.N., 2000. Effects of confining pressure and temperature on mixed-mode (I–II) fracture toughness of a limestone rock, International Journal of Rock Mechanics and Mining Sciences, 37(4), pp. 629–643.
4. Zhao Fei, 2013. Research of Mechanical Parameters with Geophysical Method in Shale Gas Reservoir, Master thesis. China University of Petroleum, Beijing.

Зразок прямошовного Бразильського диска (SNBD) використовується для випробування міцності режимів-I і режимів-II на розрив родовища сланцевого газу. Випробування проводять на 14 зразках сланцю, родовища сланцевого газу на південно-заході міста Чунцін, Китай. Щоб забезпечити точність результатів випробування, застосовується техніка гідроабразивного доведення для обробки порожнин зразків, що дозволяє уникнути впливу центрального отвору на виїмку. На основі результатів випробування встановлені моделі прогнозу міцності режимів-I і режимів-II на розрив родовища сланцевого газу. Прогнозна міцність на розрив показує достатню відповідність результатам випробування. Результати показують, що міцність на розрив режиму-I і режи-

му-II родовища сланцевого газу прямо пропорційна щільності породи та інтервалу часу пробігу, і обернено пропорційна вмісту сланцю. Моделі прогнозу можуть бути використані для встановлення безперервності профілю міцності на розрив родовища сланцевого газу та ефективно визначити вибір оптимального шару обробки перед ГРП.

Ключові слова: родовище сланцевого газу, прямошовний Бразильський диск, міцність на розрив, каротаж

Образец прямошовного Бразильского диска (SNBD) используется для испытания прочности режимов-I и режимов-II на разрыв месторождения сланцевого газа. Испытание проводят на 14 образцах сланца, месторождения сланцевого газа на юго-западе города Чунцин, Китай. Чтобы обеспечить точность результатов испытания, применяется техника гидроабразивной доводки для обработки полостей образцов, что позволяет избежать влияния центрального отверстия на выемку. На основе результатов испытания установлены модели прогноза прочности режимов-I и режимов-II на разрыв месторождения сланцевого газа. Прогнозная прочность на разрыв показывает достаточное соответствие результатам испытания. Результаты показывают, что прочность на разрыв режима-I и режима-II месторождения сланцевого газа прямо пропорциональна плотности породы и интервалу времени пробега, и обратно пропорциональна содержанию сланца. Модели прогноза могут быть использованы для установления непрерывности профиля прочности на разрыв месторождения сланцевого газа и эффективно определять выбор оптимального слоя обработки перед ГРП.

Ключевые слова: месторождение сланцевого газа, прямошовный Бразильский диск, прочность на разрыв, каротаж

Рекомендовано до публікації докт. техн. наук Р. О. Дичковським. Дата надходження рукопису 06.06.15.