

нием активного сопротивления обмотки. Теоретическое обоснование усовершенствованного метода тепловой защиты асинхронных электродвигателей при токовых перегрузках путем непосредственного определения температуры нагрева обмоток статора.

Практическая значимость. Разработан алгоритм функционирования микропроцессорного устройства защиты асинхронных электродвигателей, работающих в повторно-кратковременном режиме, от недопустимого перегрева обмоток при токах перегрузки.

Ключевые слова: асинхронный электродвигатель, микропроцессорное устройство защиты

Purpose. Theoretical justification and engineering of the method of induction motors protection from overload currents with the winding temperature direct control at the launch time and implementation as microprocessor device functioning algorithm.

Methodology. To solve the problem we used the theory of electromagnetic transients in electrical circuits. A mathematical model of the instantaneous power change of an induction motor consumption in starting transient mode was developed, in which the application of simple and widely used in relay protection, circuit breakers microprocessor trips, in particular, mathematical operations of instantaneous

current squares integration allows the most in harmony with the mathematical apparatus construction other network protection types.

Findings. The need for direct winding temperature control of induction motors was proved. To realize the control of the working in intermittent mode motor temperature by the extreme values analysis of the instantaneous power consumption of the motor at the initial time after start-up.

Originality. Theoretical research of ways to obtain information about the electrical circuit parameters in the transient mode of perturbations current variation, in particular the induction motors temperature determining by the variation winding resistance monitoring. Theoretical substantiation of induction motors thermal protection improved method at current overloads by directly detecting the temperature of the stator windings heating.

Practical value. Against impermissible heating windings at current overload algorithm of induction motors microprocessor protection operation of operating in intermittent mode was designed.

Keywords: induction motors, microprocessor protection

Рекомендовано до публікації докт. техн. наук В.Ф. Болюхом. Дата надходження рукопису 28.02.14.

Wei Han¹, Qiang Liu²,
Chunmei Pei¹, Yanqiu Wang¹,
Yong Liu¹

1 – Beijing Polytechnic, Beijing, China
2 – China Railway 16th Bureau Group City Construction
Development Co., Ltd., Beijing, China

CONTACTLESS POWER TRANSFER SYSTEM BASED ON MULTI MODEL ADAPTIVE CONTROL

Вей Хань¹, Цян Лю²,
Чуньмей Пей¹, Яньцю Ван¹,
Юн Лю¹

1 – Пекінський політехнічний університет, м. Пекін, КНР
2 – Чайна Рейлвей 16 Бюро Груп Сіті Кенстракшн Дівелопмент Ко., Лтд., м. Пекін, КНР

БЕЗКОНТАКТНА СИСТЕМА ПЕРЕДАЧІ ЕНЕРГІЇ З БАГАТОМОДЕЛЬНИМ АДАПТИВНИМ УПРАВЛІННЯМ

Purpose. For the contactless inductive power transfer (CIPT) system, the power is transferred by the mutual inductance coupling, which results in many problems, such as speed, reliability, and stability. This paper puts forward a method of contactless power transfer based on multi-model adaptive control.

Methodology. This method adjusts the duty cycle of control pulse by using the fuzzy control algorithm, and thus to control the output voltage.

Findings. This paper brings in the theories related to the multi-model reference adaptive control, establishes an ideal model for CIPT system, and obtains an approximate curve of the output voltage in the ideal model by way of curve fitting. By using fuzzy controller, the output voltage may well real-time track the ideal reference model.

Originality. The proposed fuzzy control method of multi-model adaptive duty cycle may improve the performance of the contactless power transfer system.

Practical value. The method proposed in the paper can ensure that the output voltage could be kept constantly at an ideal value after the system came to a steady state. The experimental result shows the efficiency of this algorithm.

Keywords: contactless inductive power transfer, multi model, control pulse, duty cycle, curve fitting, fuzzy control

Introduction. As a new technology, CIPT has no standard definition at present. However, it also has a

common ground: power transfer to non-conductor mechanical connection and power supply and use equipment relatively movable may be achieved by loose coupling. As a result, traditional power transfer mode for tight coupling transform-

ers and induction machines is not included. CIPT is a multi-disciplinary technology integrating modern power electronics technology, control theory and electromagnetic theory, etc. Besides, many fields like power conversion technology, power flow adjustment, control theory, and magnetic coupling need to be delved into at the same time [1].

Contact power transfer system is a typical object having a great delay and inertia. Due to changes in magnetic mechanism distance and load, parameters in the system model are time-variation, elements and magnetic materials comprising the system are non-linear to some extent, field interference is relatively large, and accurate mathematical model cannot be easily obtained. The greatest advantage of fuzzy control does not require the controlled object to have accurate mathematical expression [2], interference nonlinear indexes then can be restricted, and parametric variation of the controlled object have relatively strong anti-interference performance. For contactless power transfer system with loose coupling characteristics, no electrical connection existing between original and secondary-side magnetic coil mechanism and the power transfer can be achieved only by circuit coupling. During the operational process of contactless power transfer system, both original and secondary-side magnetic mechanism are inevitably changed by external influences, and the mutual inductance value is then affected [3]. The load switching and disturbance may also exert an influence on system output voltage, and stable voltage is important and crucial in electrical vehicle charging system [4]. Due to the non-linear, time variation and uncertainty of contactless power transfer system, the accurate mathematical model cannot be easily obtained. For traditional PID control, it has a strong dependence on the object transfer function model and parameters [5]. The rational design of adaptive law is a core problem in reference system design of the model. To ensure the system's reliable operation, the adaptive law can be designed by using Liapunov Direct Method or Popov Super Stabilization Theory [6–7]. On these grounds, this paper puts forward a contactless power transfer method based on multiple model adaptive control, and thus to effectively improve the performance.

Multiple model adaptive control based on optimization model set. Based on traditional adaptive control, Multiple Model Adaptive Control (MMAC) has developed as an effective way to solve complex system problems, including nonlinear, off-design condition, strong disturbance, and parameter uncertainty.

The multiple model adaptive control mainly consists of the following three parts.

1) To establish multi-models according to the uncertainty in model parameter structure of the controlled object, and constitute a set of multi models.

$$\Omega = \{M_i | i = 1, 2, \wedge, n\}.$$

2) To constitute a set of multi controller according to different models in model set Ω .

$$C = \{U_i | i = 1, 2, \wedge, n\}.$$

3) Given switching principle: select the current optimization model of the controlled object and switch the con-

troller designed based on optimization model as the current optimization.

$$U_{sys} = f(U_1, U_2, \wedge, U_n, \theta).$$

Establish the Dynamic Optimization Model Set. This paper adopts the way of dynamic optimization model set to establish model sets, of which the parameters can be adjustable or fixed. Different models have different advantages and disadvantages: adaptive controller constituted by using multi-adaptive models is relatively large from the perspective of calculated amount; because model parameters need to be dynamically adjusted, parameters of adaptive models needs to be re-given; only parameter values relatively near actual parameters, parameters of the controller can be ensured of fast identification. However, fixed models have no these disadvantages. It can be applied to time-variant or time-invariant system, but control accuracy cannot be guaranteed. A better control can be obtained by integrating multi-fixed models and multi-adaptive models.

Self-Tuning Control of Pole Assignment. In relation to the dynamic optimization model set, the self-tuning controller design of pole assignment is applied. The basic structure diagram is shown in fig. 1.

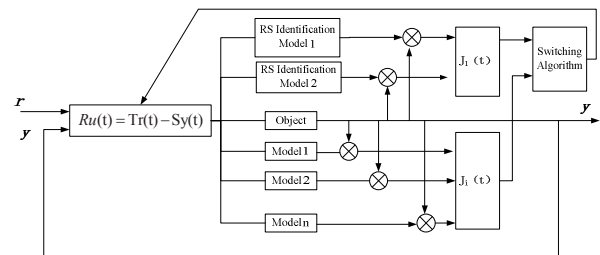

Fig. 1. Self-Tuning Control Structure of Multi Model Pole Assignment in Optimization Model Set

Consider the controlled object with single input single output discrete time described by the following ARMA model.

$$A(k, q^{-1})y(k) = B(k, q^{-1})u(k) + \varepsilon(k).$$

Of which, $u(k)$ and $y(k)$ are process input and output, $A(k, q^{-1})$ and $B(k, q^{-1})$ are moment k and polynomial of backward shift operator q^{-1} , and $\varepsilon(k)$ is white noise.

$$A(k, q^{-1}) = 1 + a_1(k)q^{-1} + \wedge + a_n(k)q^{-n};$$

$$B(k, q^{-1}) = b_0(k) + b_1(k)q^{-1} + \wedge + b_m(k)q^{-m}.$$

Assume parameters of $A(k, q^{-1})$ and $B(k, q^{-1})$ are unknown, but both satisfy the parameter vector below

$$\theta(k)^T = [a_1(k), \wedge, a_n(k); b_0(k), b_1(k), \wedge, b_m(k)].$$

It changes in bounded convex set Ω and satisfy the coprime between $A(q^{-1}, k)$ and $B(k, q^{-1})$.

The controlled object can be written as below

$$y(k) = \phi(k-1)^T \theta(k).$$

Of which,

$$\phi(k-1)^T = [-y(k-1), -y(k-2), \wedge, -y(k-n), u(k-1), \wedge, u(k-m)].$$

Use least square regression algorithm with exponential weighting defined as below to estimate model parameters of controlled objects.

$$\hat{\theta}(k+1) = \hat{\theta}(k) + P(k+1)\Psi(k+1)[y(k+1) - \Psi^T(k+1)\hat{\theta}(k)];$$

$$P(k+1) = \left[P(k) - \frac{P(k)\Psi(k+1)\Psi^T(k+1)P(k)}{\lambda + \Psi^T(k+1)P(k)\Psi(k+1)} \right] \bullet \frac{1}{\lambda}.$$

Exponential weighting refers to the exponential discount of previous measured value, it could track the time variation and nonlinear.

Variation of System. The equation parameter λ is forgetting factor, which is mainly within the scope of $0.95 < \lambda < 1$. The change speed of system plays a decisive role; the smaller λ is, the faster the forgetting speed has. It can be used to deal with system issues such as the nonlinear and rapid variation. When λ approximates to 1, the forgetting speed may be slower and it can be used in the process of system gradual change.

Switching Algorithm. Establish multi fixed models for controlled objects based on different operating points

$$A_i(q^{-1})y_1(t) = B_i(q^{-1})u(t-1), \quad i \in \{1, 2, \wedge, N\};$$

$$A_i(q^{-1}) = (1 + a_{i1}q^{-1} + \wedge + a_{mi}q^{-m});$$

$$B_i(q^{-1}) = (b_{0i} + b_{1i}z^{-1} + \wedge + b_{mi}z^{-1}).$$

To select a set of models nearest to the controlled objects, the following performance indexes are established.

$$J(t) = \sum_{k=1}^t \alpha(k)^{t-k} |y_1(k) - \theta_i^T \phi(k-1)|, \quad i \in \{1, \wedge, N\};$$

$$\theta_i = [-a_{i1}, \wedge, -a_{mi}; b_{0i}, \wedge, b_{mi}]^T, \quad i \in \{1, \wedge, N\}, \quad 0 < \alpha < 1.$$

Of which, $\theta_i = [-a_{i1}, \wedge, -a_{mi}; b_{0i}, \wedge, b_{mi}]^T$, $i \in \{1, \wedge, N\}$, $0 < \alpha < 1$ is a weighting factor.

Establish two parameter estimators for the controlled objects, conduct optimal adjustment to the initial value dynamic of the first estimator. After setting initial value for the second estimator, keep initial value unchanged in the identification process and establish the switching index.

$$\hat{J}(t) = \sum_{k=1}^t \alpha(k)^{t-k} |y_1(k) - \hat{\theta}_l^T \phi(k-1)|, \quad l \in \{1, 2\}.$$

If the performance index of fixed model is smaller than that of the adaptive model, the system shall be switched to the fixed model and its corresponding controller, and give a new initial value to the adaptive identification model. The

re-given initial value can be deemed as a parameter value of switched fixed model. Conversely, the system shall be switched to adaptive model and its corresponding adaptive controller. If this model is a common adaptive model, the given initial value of adaptive identification model can be deemed as a parameter value of switched adaptive model. If no initial value of the adaptive identification model can be switched, the following specific algorithm may be used.

If $\hat{J}_{l(t)}(t) \leq J_{l(t)}(t)$, then $\hat{\theta}(t) = \hat{\theta}_{l(t)}$;

If $l(t) = 2$, then the given initial value of the first adaptive identification model is $\hat{\theta}_1(t) = \hat{\theta}_{l(t)}$;

If $l(t) = 1$, no initial value can be switched;

If $\hat{J}_{l(t)}(t) > J_{l(t)}(t)$, then $\hat{\theta}(t) = \hat{\theta}_{l(t)}$, $\hat{\theta}_1(t) = \hat{\theta}_{l(t)}$.

Fuzzy adaptive control system with reference model.

The fuzzy control is based on the fuzzy mathematics, fuzzy set theory, fuzzy language variables, and fuzzy logical reasoning. It is an intelligent control method, which uses fuzzy set to represent variables and adopts fuzzy logical operation to make inference decision. The core in fuzzy control system is fuzzy controller, comprising three parts as below [8]:

1. Fuzzification. To use colloquial variables to describe measured voltage deviations.
2. Fuzzy Reasoning. To obtain fuzzy output values of the fuzzy controllers by using fuzzy reasoning approach in accordance with the fuzzy control rule base.
3. Defuzzification. To transfer fuzzy output values to accurate controlled variables, which can be directly affected the controlled objects.

A common fuzzy controller always selects the output variable deviation value of the controlled object: e and deviation variation rate: de to be input variables, and the accurate controlled variables obtained by defuzzification to be output. In this chapter, control system may real-time collect DC output voltage $u_0(k)$ in CIPT system, and DC output voltage error amount $e(k)$ and its corresponding differential $de(k)$ of the k th sampling period.

$$\begin{cases} e(k) = u_{ref} - u(k) \\ de(k) = e(k) - e(k-1) \end{cases}$$

By using triangle fuzzy model as the membership function, the membership functions with error: e , error variation rate: de and output control variable: u can be seen in the fig. 2, 3.

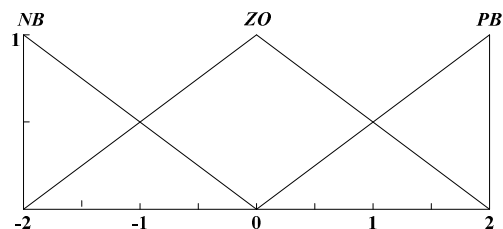

Fig. 2. Input Membership Function $e(k)$ and $de(k)$

Based on the idea stated above, this paper will introduce the defuzzification method. Assume eL is boundary value of the retention phase and fine-tuning phase, eH is boundary value of the fine-tuning phase and coarse-tuning phase, eM

is maximum error can be adjusted by the fuzzy controller, and u_0 is the previous state output value of the fuzzy controller.

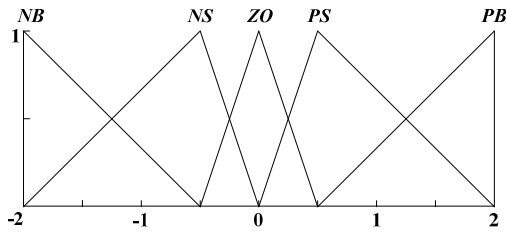

Fig. 3. Outputs Membership Function u

$$u = \frac{\sum_{i=1}^n \omega_i u_i}{\sum_{i=1}^n \omega_i} = \frac{\omega_1 u_1 + \omega_2 u_2 + \dots + \omega_n u_n}{\omega_1 + \omega_2 + \dots + \omega_n}$$

The calculation equation of weight in i th rule is

$$\omega_i = R_i \prod_{j=1}^k A_j^i = R_i A_1^i(x_1) A_2^i(x_2) \dots A_k^i(x_k)$$

It means multiplying input variable x_j in the i th rule with membership of each subset and then with the identified weight R_i . The identified weight R_i refers to a proportion that i th rule accounted in the total output by designers under the condition that unaffected by input membership function. It can adjust the weight of this rule somehow, and for easy calculation, $R_i=1$ is often adopted.

Due to different conditions, the system electrical characteristics and requirements on system accommodation time may be different. Consequently, the foregoing boundary values and coefficient values may be repeatedly adjusted and settled according to the experience of designers.

Model Establishment and Analysis. The CIPT system structure based on fuzzy control strategy is shown in fig. 4. The control system is composed of CIPT main circuit, detection circuit of DC output voltage, fuzzy control circuit, PWM modulator, drive magnify circuit, etc. The fuzzy controller and fuzzy algorithm, PWM modulator, etc. are constituted by the controller with core of TMS320F2812 DSP CPU.

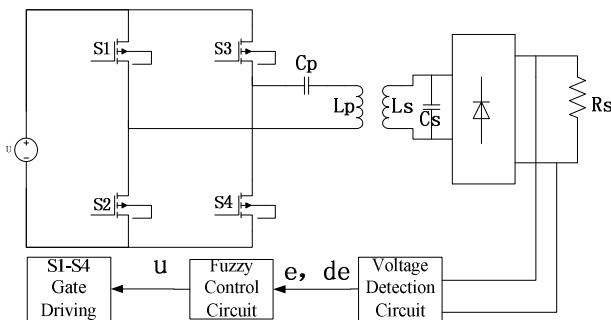

Fig. 4. CIPT System Principle Diagram Based on Fuzzy Control

Fig. 5 is PWM control signal for four switches on primary H Bridge. If the cycle T remains unchanged, the output electric voltage of secondary circuit can be adjusted by changing the duty cycle α . As shown in fig. 5, if cycle T remains unchanged and the duty cycle $\alpha=0.5T$, the output electric voltage of secondary circuit could reach the highest value. If α comes close to 0 or T , output electric voltage of secondary circuit may be gradually reduced to 0.

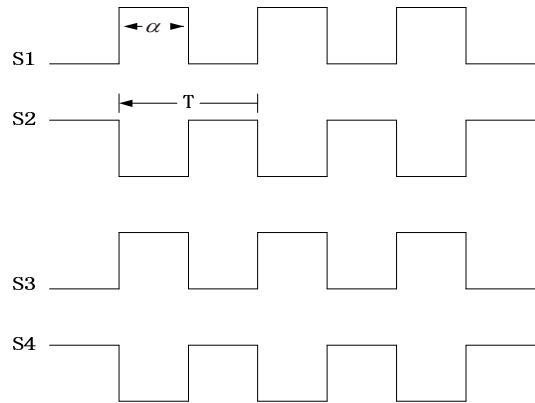

Fig. 5. PWM Control Signal

Control Algorithm. To obtain the accurate sampling of the actual output voltage by AD, and to calculate output voltage of the reference model, the difference between these two is marked as E , and the ratio between error and sampling time is marked as error variety rate EC . The step size of duty cycle change is U . besides, E and EC may be conducted with fuzzification. E would be conducted with fuzzification in three scopes: high error, ok error, and low error. EC would be conducted with fuzzification in three scopes: positive change, ok change, and low negative change. The defuzzification for U can be divided into five accurate steps: open-fast, open-slow, no-change, close-slow and close-fast.

By these five accurate steps of U , in accordance with step size of duty cycle change on real-time based on actual conditions, errors can be eliminated as soon as possible, and the overshoot may be reduced at the same time. If an error is relatively large, the change of controlled variables should enable errors to be reduced as rapid as possible. If an error is relatively small, other than eliminating errors, the system stability should be considered at the same time to avoid larger overshoot and even vibration produced by the system. In this way, quick response and stable convergence can be achieved.

The established fuzzy rule ought to go through the fuzzy reasoning before deciding a fuzzy subset of control variables. As a fuzzy variable, it cannot directly control the controlled objects and need to be transferred as an accurate control variable that can be directly affected on the controlled objects. The fuzzy condition statement of fig. 1: IF (e =corresponding elements in the first column, de =corresponding elements in the first line), THEN (u =corresponding elements in the table). The u_1 can be calculated by the first statement. In a similar way, all elements can be represented by other statements.

Fuzzy Rule Query Form

$\begin{matrix} u & de \\ \swarrow & \searrow \\ e \end{matrix}$	-6	-5	-4	-3	-2	-1	0	+1	+2	+3	+4	+5	+6
-6	7	6	7	6	7	7	7	4	4	2	0	0	0
-5	6	6	6	6	6	6	6	4	4	2	0	0	0
-4	7	6	7	6	7	7	7	4	4	2	0	0	0
-3	7	6	6	6	6	6	6	3	2	0	-1	-1	-1
-2	4	4	4	5	4	4	4	1	0	0	-1	-1	-1
-1	4	4	4	5	4	4	1	0	0	0	-3	-2	-1
-0	4	4	4	5	1	1	0	-1	-1	-1	-4	-4	-4
+0	4	4	4	5	1	1	0	-1	-1	-1	-4	-4	-4
+1	2	2	2	2	0	0	-1	-4	-4	-3	-4	-4	-4
+2	1	2	1	2	0	-3	-4	-4	-4	-3	-4	-4	-4
+3	0	0	0	0	-3	-3	-6	-6	-6	-6	-6	-6	-6
+4	0	0	0	-2	-4	-4	-7	-7	-7	-6	-7	-6	-7
+5	0	0	0	-2	-4	-4	-6	-6	-6	-6	-6	-6	-6
+6	0	0	0	-2	-4	-4	-7	-7	-7	-6	-7	-6	-7

If the control variable is fuzzy set u, it can be expressed as

$$u = u_1 + u_2 + \dots + u_n.$$

The control fuzzy variable can be transferred to control accurate variable by using the maximum membership method, and thus to control the controlled objects.

For example, the first fuzzy condition statement

IF e=NB or NM and de=NB or NM THEN u=PB.

Then the control variable can be obtained

$$u_1 = e \circ [(NB_e + NM_e) \times PB_u] \bullet de \circ [(NB_{de} + NM_{de}) \times PB_u].$$

If the membership function values of e and de select 1 on corresponding quantitative grade and 0 on others, then it can be simplified as

$$u_1 = \min\{\max[\mu_{NB_e}(i); \mu_{NM_e}(i)]; \max[\mu_{NB_{de}}(j); \mu_{NM_{de}}(j)]; \mu_{PB_u}(x)\}.$$

The corresponding fuzzy rule query form can be obtained by the calculation method stated above. Save this form in DSP, and when conducting real-time control, required control strategies can be queried according to output voltage errors and error changes. The effect of fuzzy constant pressure control is to query this form and to control the input voltage in compliance with the fuzzification level in errors and error changes.

Experimental results and analysis. Reference/actual model are mainly constituted by original and secondary-side circuits. The main body of original-side circuit is an H bridge, including four IGBT switching tubes. The secondary-side circuit is mainly composed of full-bridge rectifier and loads, in which the loads are simulated by the multiple of one capacitance and one resistance. The original-side resonance capacitance is in series, and secondary-side resonance capacitance is in multiple.

System Parameter Setting.

System frequency: f=20kHz

Original-side inductance: l1=190μh; secondary-side inductance: l2=110μh; coupling inductance: M=78.75μH, M1= 73μH, M2=68μH; original-side compensation capacitance: C1 =370μ; secondary-side compensation capacitance: C2= 57.57nF.

Simulation Process. The output voltage and current of the H Bridge 0ms-2m: (square wave-original-side voltage, sine-original-side current)

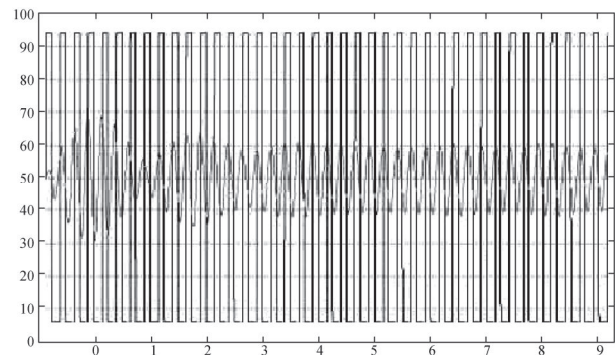

Fig. 6. Output voltage and current of the H Bridge 0ms-2m

The output voltage and current of H Bridge 11-12.5ms: (square wave-original-side voltage, sine-original-side current)

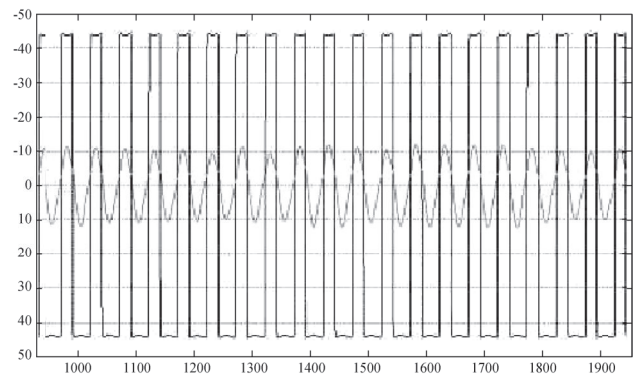

Fig. 7. Output voltage and current of the H Bridge 11-12.5ms

The load voltage and current of reference model: (black curve-load voltage, black half wave-load current)

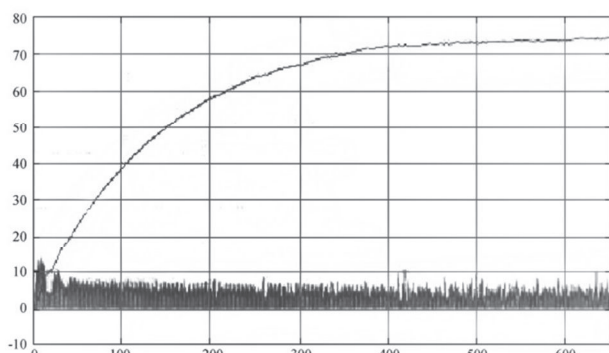

Fig. 8. Load voltage and current of reference model

Comparison of actual model and reference model: (black-actual output, grey-reference output)

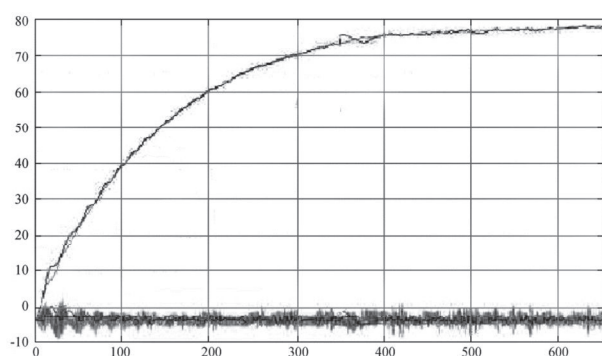

Fig. 9. Comparison of actual model and reference model

Through simulation experiment results of the above Matlab, we can obtain analysis result as stated below:

1. It can be seen from simulation results, the system can well track outputs of the reference model, and achieve non-overshoot and stable output when ensuring quick response.

2. Both smaller and larger coupling inductance would reduce the output voltage. If the positive and negative changes of coupling inductance are not large, the system could compensate the reduction of the output voltage by adjusting the duty cycle. If the positive and negative changes of coupling inductance are large, the system cannot compensate the reduction of output voltage by adjusting the duty cycle, and even may lead to the inevitable voltage deviation. However, in the case of deviation, the output voltage may also remain stable.

3. Through observing the voltage tracking records in different coupling inductances, it is found that the system can well track the voltage of reference model when coupling inductance is from $67\mu\text{H}$ to $83\mu\text{H}$. In the event that it exceeds the foregoing scope, the system will stably output voltage nearest reference model in this coupling condition.

4. To simplify the achievement of DSP procedure and enforce the system robustness, a simplest fitting model is obtained by using the curve fitting approach.

5. Through comparing different tracked fitting models, it is founded the records have rather smaller differences with the actual results. The actual output tracking of the simplest fitting model and tracked reference model could achieve the dynamic and stable indexes of output voltage.

6. If the set value of DSP's compare register is oversize, pulse losing may occur when comparing with triangular wave. If the set value is undersize, the adjustable range of duty cycle may be narrowed down.

7. If set membership permissible range of error E is oversize, overshoot may occur. If the set membership permissible range of error E is undersize, larger joggle may occur in the stable phase.

8. If set membership permissible range of error variety rate EC is oversize, the fuzzy control may not be fully used. If the set membership permissible range of error E is undersize, larger joggle may also occur in the stable phase.

Conclusion. This paper proposes to adjust the duty cycle of control pulse by using fuzzy control algorithm, and thus to control the output voltage. This paper brings in theories related to the multi model reference adaptive control, establishes an ideal model for output voltage model, and obtains an approximate curve of ideal model output voltage by the way of curve fitting. By using fuzzy controller, the output voltage may well real-time track the ideal reference model and be kept constantly at an ideal value after the system came to a steady state.

References / Список літератури

1. Chwei-Sen, W., Covic, G.A. and Stielau, O.H. (2010), "Power transfer capability and bifurcation phenomena of loosely coupled inductive power transfer systems", *IEEE Trans. on Ind. Electron.*, vol.51, no.1, pp. 148–156.
2. Jinsong, L. and Min, L. (2010), "Status Quo and Development of Fuzzy Control. Tongren Vocational Technical Institute", *Journal of Tongren Vocational Technical Institute (the Natural Science Edition)*, vol.8, no.5, pp. 39–42.
3. Hirai, J., Kim, T.W. and Kawamura, A. (2000), "Wireless transmission of power and information for cableless linear motor drive", *IEEE Trans. on Power Electron.*, vol.15, no.1, pp. 21–26.
4. Chen, M., Xu, D. and Zhou, D. (2004), "Inductive power transferring in maglev using harmonic injection method", *IEEE Applied Power Electronics Conference and Exposition-APEC*, pp. 1165–1170.
5. Seema, B. Vora, Ami K. Vibhakar (2012), "Wireless energy transfer", *International Journal of Scientific Engineering and Technology*, vol.1, no.1, pp. 5–10.
6. Tianhua, L. (2010), "Research on Several Methods of Intuitionistic Fuzzy Reasoning and Decision", Shandong University.
7. Ki Young Kim (2012), "Wireless power transfer-principles and engineering explorations", Book published by InTech.
8. Robert, W.E. and Dragan, M. (2004), "Fundamentals of Power Electronics (Second Edition)", Kluwer Academic Publishers, New York, pp. 723–726.

Мета. У системах індукційної безконтактної передачі електричної енергії (СІРТ), передача здійснюється через індуктивний зв'язок, що породжує проблеми слабкої швидкості передачі, надійності та стійкості. У статті запропоновано метод безконтактної передачі електричної енергії з багатомодельним адаптивним управлінням.

Методика. Цей метод регулює робочий цикл імпульсу управління, використовуючи алгоритм нечіткої логіки, таким чином, для управління контролюючи вихідною напругою.

Результат. У роботі винесені на розгляд теорії, пов'язані з багатомодельним адаптивним управлінням, визначена ідеальна модель СІРТ-системи та наведена, отримана за допомогою вирівнювання експериментальних даних, приблизна крива вихідної напруги в ідеальній моделі. З використанням нечіткого контролера, вихідна напруга відповідатиме еталонній моделі.

Наукова новизна. Запропонований метод нечіткого контролю багатомодельного адаптивного робочого циклу дозволить поліпшити показники роботи систем безконтактної передачі електричної енергії.

Практична значимість. Запропонований метод може гарантувати, що вихідна напруга зберігатиме задане значення після того, як система ввійде до сталого режиму. Результати експериментальних досліджень підтверджують ефективність алгоритму.

Ключові слова: індукційна безконтактна передача електричної енергії, багатомодельний, імпульс управління, режим роботи, вирівнювання експериментальних даних, нечіткий контроль

Цель. В системах индукционной бесконтактной передачи электрической энергии (СИРТ), передача осу-

ществляется через индуктивную связь, что порождает проблемы слабой скорости передачи, надежности и устойчивости. В статье предложен метод бесконтактной передачи электрической энергии с многомодельным адаптивным управлением.

Методика. Этот метод регулирует рабочий цикл импульса управления, используя алгоритм нечеткой логики, таким образом, для управления контролируя выходным напряжением.

Результат. В работе вынесены на рассмотрение теории, связанные с многомодельным адаптивным управлением, определена идеальная модель СИРТ-системы и приведена, полученная с помощью выравнивания экспериментальных данных, приближительная кривая выходного напряжения в идеальной модели. С использованием нечеткого контроллера, выходное напряжение будет соответствовать эталонной модели.

Научная новизна. Предложенный метод нечеткого контроля многомодельного адаптивного рабочего цикла позволит улучшить показатели работы систем бесконтактной передачи электрической энергии.

Практическая значимость. Предложенный метод может гарантировать, что выходное напряжение будет сохранять заданное значение после того, как система войдет в установившийся режим. Результаты экспериментальных исследований подтверждают эффективность алгоритма.

Ключевые слова: индукционная бесконтактная передача электрической энергии, многомодельный, импульс управления, режим работы, выравнивание экспериментальных данных, нечеткий контроль

Рекомендовано до публікації докт. техн. наук Ф.П. Шкрабцем. Дата надходження рукопису 15.09.14.